

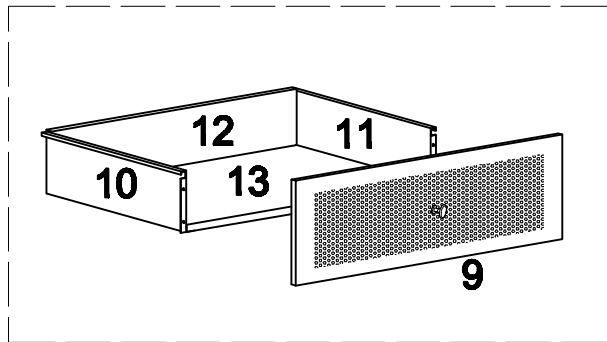

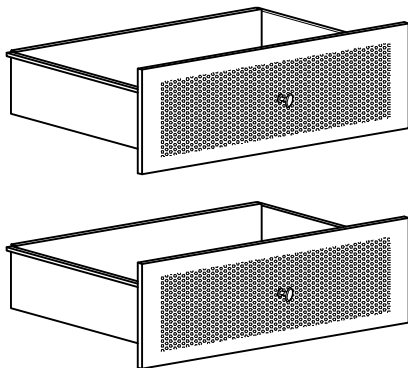

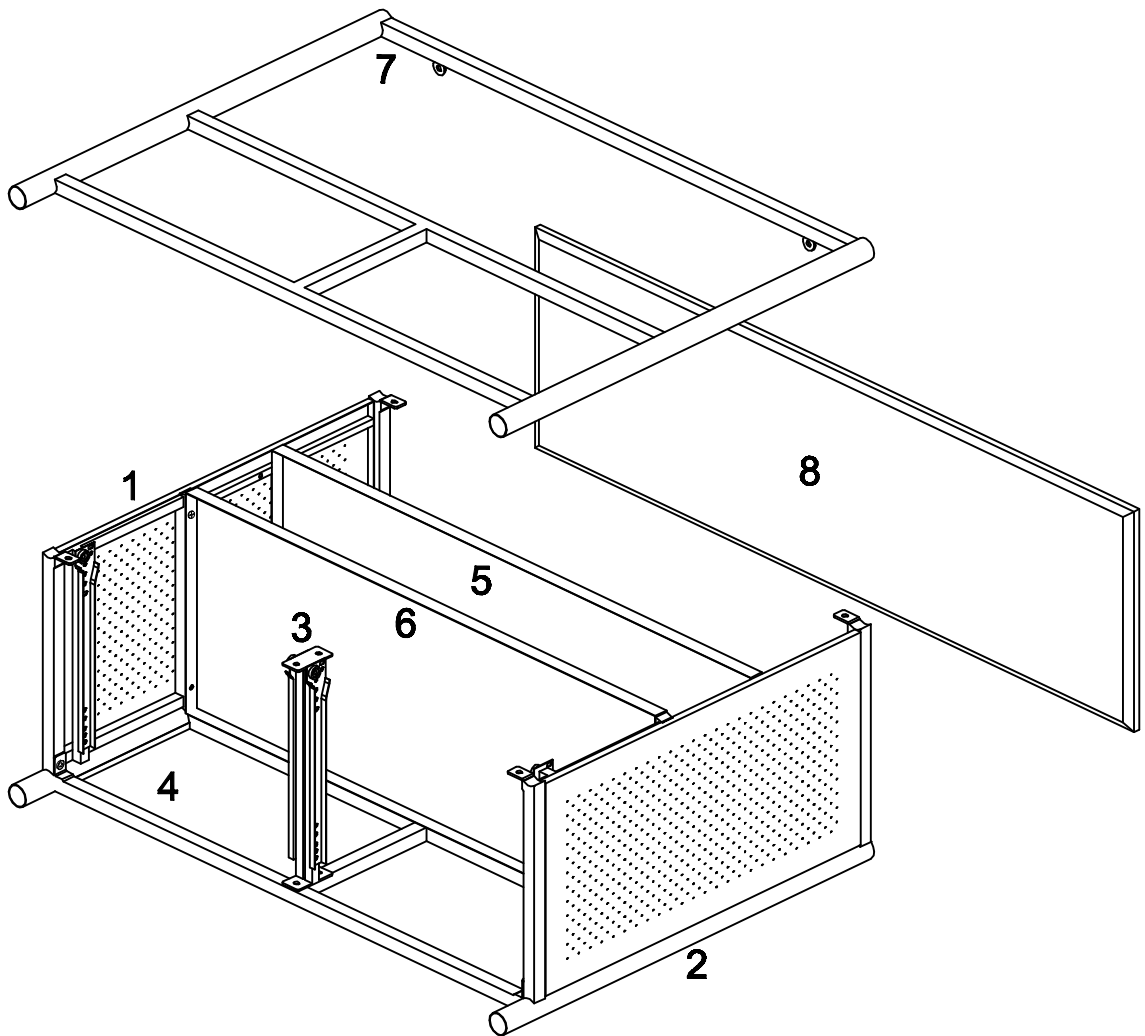

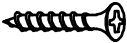



AMEC Parts List



Hardware List

A	 Ø4*10	Philips screw	16 pcs
B	 Ø16mm	Washer	16 pcs
C	 Ø1/4**1/2"	Bolt	16 pcs
D	 Ø3/16**10mm	Philips machine screw	24 pcs
E	 M4*10mm	Philips machine screw	2 pcs
F	 Ø3/16"	Cap nut	8 pcs
G		Knob	2 pcs
H		Left drawer slide arm	2 pcs
I		Right drawer slide arm	2 pcs
J		Left drawer slide bracket	2 pcs
K		Right drawer slide bracket	2 pcs
L		Wrench	1 pc

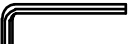
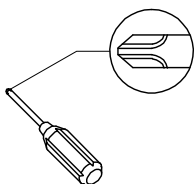

Philips head screwdriver required for assembly
(not included)

